

PLAN VIEW

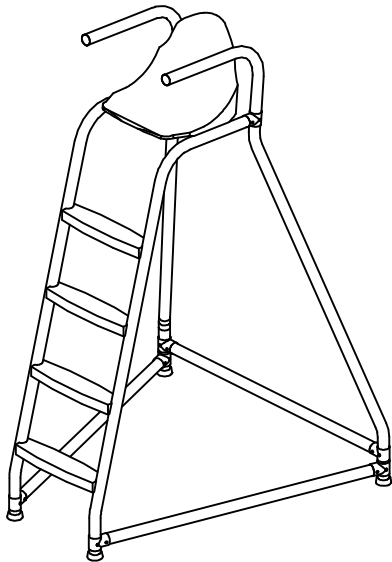

3D VIEW

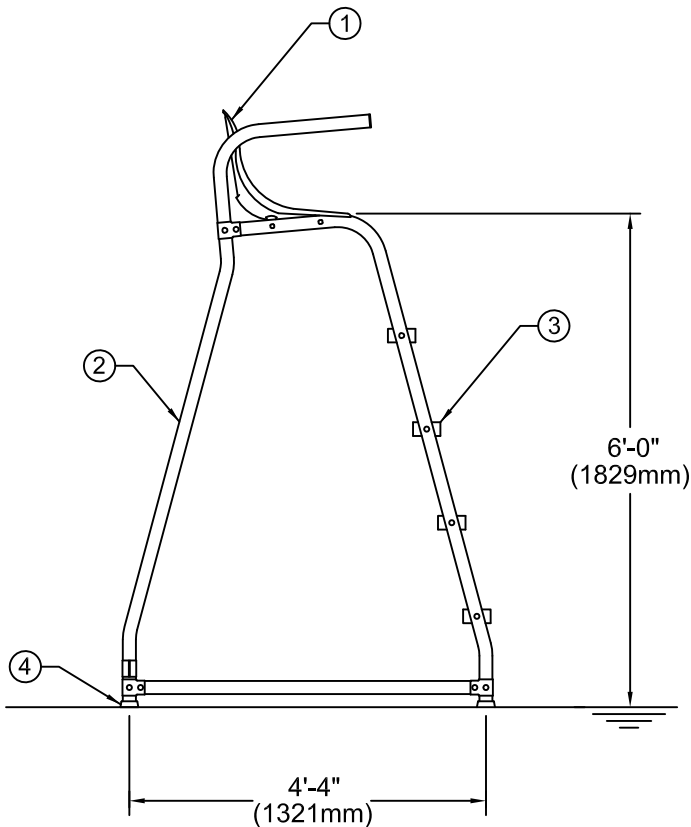

SIDE VIEW

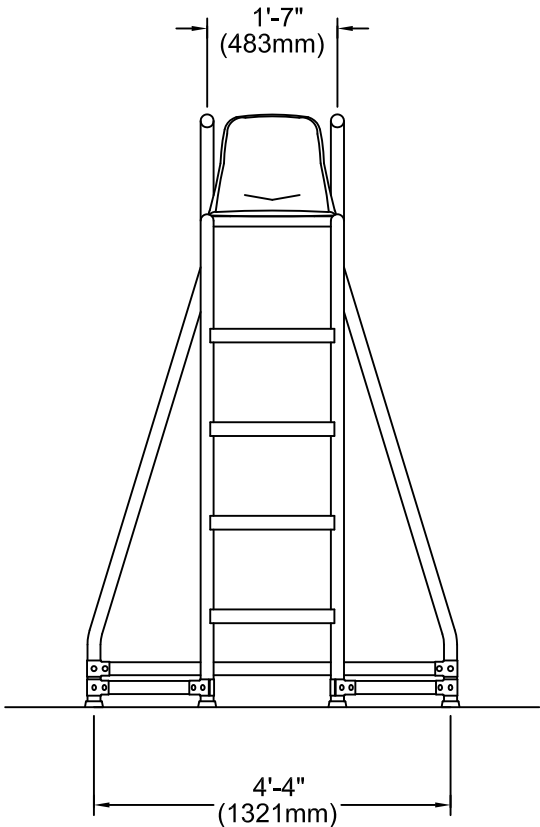

FRONT VIEW



1-800-935-4878 • info@aquam.com

This document is, at all times, the property of Aquam Aquatic Specialist Inc., and may not be used or reproduced without written consent.

PORTABLE LIFEGUARD CHAIR 4 STEPS











PRODUCT NUMBER : SA-57550

SCALE : 1 = 1/28

REVISION 01 : 2020 / 03 / 11

SPECIFICATIONS

- ① THE FIBERGLASS SEAT (SA-57625) IS LOCATED AT 6'-0" (1829mm), ABOVE THE POOL DECK.
- ② TUBING OF THE LIFEGUARD CHAIR IS SUPPLIED IN CONTINUOUS SMOOTH LENGTHS.
- ③ THE MOUNTING STEPS ARE BUILT OF WHITE ABS PLASTIC (DV-82428). THE STEPS ARE 17" (432mm) LONG, A WIDTH OF $4\frac{1}{16}$ " (103mm) AND A THICKNESS OF $1\frac{3}{4}$ " (45mm). THEY ARE INSTALLED AT AN ANGLE OF 15° AND HAS A NONSKID SURFACE.
- ④ THE POSTS OF THE STRUCTURE HAVE RUBBER BUMPERS (DV-82488) INSTALLED ON THEM TO PREVENT DAMAGE TO POOL DECK TILES, AS WELL AS AID IN PREVENTING MOVEMENT OF THE CHAIR WHILE IN USE.

COLOUR SELECTION										
NO COLOUR STANDARD	RAL 5010	RAL 7015	RAL 6029	RAL 1016	RAL 2004	RAL 3020	RAL 3003	RAL 5015	PANTONE 267C	BENGAL SILVER
										
<input type="checkbox"/>	<input type="checkbox"/>	<input type="checkbox"/>	<input type="checkbox"/>	<input type="checkbox"/>	<input type="checkbox"/>	<input type="checkbox"/>	<input type="checkbox"/>	<input type="checkbox"/>	<input type="checkbox"/>	<input type="checkbox"/>

GENERAL INFORMATION

- SS304
- ASTM-554
- 320 GRIT FINISH
- TUBING Ø1.90" (48mm) x .065" (2mm)

REPLACEMENT PARTS	
ITEM	DESCRIPTION
SA-57625	BLUE SEAT FOR LIFEGUARD CHAIR
DV-82488	LADDER BUMPER Ø1.9" (48mm) x .065" (2mm)
DV-82428	ANGLED 17" (432mm) PARAGON TREAD